

MINDEO

MD2 Series Barcode Scanner

User Manual



Version: MD2_UM_EN_V3.2.10

Warning: Ensure that the optional DC adapter works at +5V, especially for the RS-232 interface cable.

NOTICE:

1. All software, including firmware, furnished to the user is on a licensed basis.
2. The right is reserved to make changes to any software or product to improve reliability, function, or design.
3. The material in this manual is subject to change without notice.
4. A standard packing includes a scanner, a PS2 cable and a CD (or a user manual). Accessories include a stand, a RS-232 cable, a 5V adaptor and a USB cable.

Contents

Technical specifications	1
Cable connector pin-outs descriptions	2
Default setting for each barcode.....	3
Default setting for each barcode.....	3
Decode zone.....	4
Dimensions	5
Parts of the scanner	6
Introduction to installation	7
Scanning modes	9
Programming instruction.....	10
Operate the scanner by receiving command via UART	11
Interface selection.....	12
Keyboard wedge interface.....	13
RS-232 interface	16
USB interface.....	18
Hand-held scan & some global settings	20
Indication	23
Auto-detection scan	24
One step setting	24
UPC-A.....	25
UPC-E.....	27
UPC-E1	29
EAN-13 (ISBN/ISSN).....	31
EAN-8	33
Code 39 (Code 32, Trioptic Code 39).....	34
Interleaved 2 of 5	36
Industrial 2 of 5.....	37
Matrix 2 of 5	38
Codabar	39
Code 128.....	40
UCC/EAN 128	41
ISBT 128	42

Code 93.....	43
Code 11.....	44
MSI/Plessey.....	45
UK/Plessey.....	46
China Post.....	47
GS1 DataBar (GS1 DataBar Truncated).....	48
GS1 DataBar Limited.....	49
GS1 DataBar Expanded.....	50
China Finance.....	51
G1-G6 & FN1 substitution string setting.....	53
G1-G4 string position & Code ID position.....	56
String transmission.....	57
Test Chart.....	59
Test Chart (Continued).....	60
Troubleshooting.....	61
Maintenance.....	62
Assembling the stand.....	63
ASCII Table.....	64
Barcode representing non-printable character.....	65
Return default parameters & others.....	66
Configuration alphanumeric entry barcode.....	67

Technical specifications

Table 1-1 Technical specifications

Input voltage	5 VDC ± 0.25V	
Power	500 mW (Operating); 650 mW (Max.)	
Current	100 mA (Operating); 130 mA (Max.)	
Standby current	<250µA	
Laser	645-660nm laser diode	
Decoding rate	200 times/sec	
Scanning angle	±60°, ±65°, ±42° (Skew, Pitch, Roll)	
Decode capability	UPC-A, UPC-E, UPC-E1, EAN-13, EAN-8, ISBN (Bookland EAN), ISSN, Code 39, Code 39 full ASCII, Code 32, Trioptic Code 39, Interleaved 2 of 5, Industrial 2 of 5, Matrix 2 of 5, Codabar (NW7), Code 128, UCC/EAN 128, ISBT 128, Code 93, Code 11 (USD-8), MSI/Plessey, UK/Plessey, China Post, China Finance, GS1 DataBar (formerly RSS) variants	
Indicator	Beeper, LED	
Interface supported	Keyboard wedge, RS-232, USB Keyboard, USB virtual COM	
Operating mode	Hand-held, Auto-detection (Optional)	
Dimensions	Height × Width × Depth: 9.5cm × 6.7cm × 15.4cm	
Weight	168g, without cable	
Cable	Straight 2.0m	
Connector type	RJ-45 phone jack connector	
Case material	PC+TPU	
Temperature	0° to 50°C (32° to 120°F), Operating; -40° to 60°C (-40° to 140°F), Storage	
Humidity	5% to 95% (non-condensing)	
Programming method	Manual (reading special barcode)	
Program upgrade	Online	
Decoding depth & Min. element width	(1 mil = 0.0254mm) Long-Range series 5 mil: 40-110mm 10 mil: 10-280mm 13 mil: 15-315mm 16 mil: 25-385mm 35 mil: 145-630mm	High-Density series 3 mil: 5-50mm 10 mil: 10-85mm 13 mil: 10-150mm 16 mil: 25-165mm 35 mil: 145-295mm
Safety	Laser safety: EN60825-1, Class 1 EMC: EN 55022, EN 55024 Electrical safety: EN 60950-1 Drop resistance: Multiple 4.0m (13.1 ft) drops to concrete Protection class: IP52	

Cable connector pin-outs descriptions

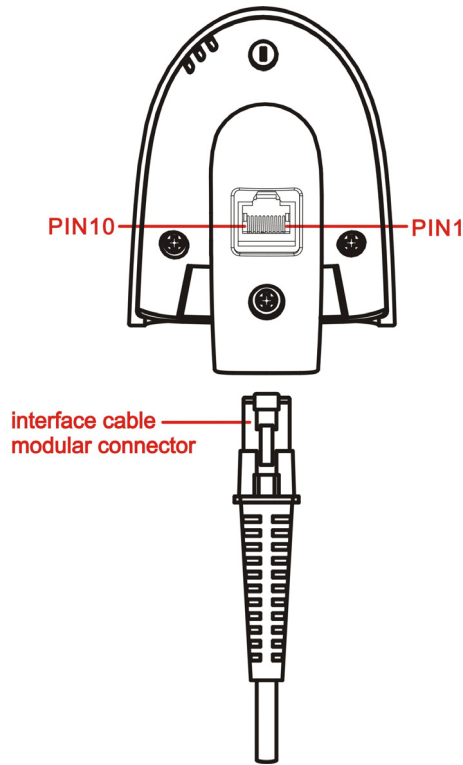

Cable connector interface pin-outs

The pin-outs descriptions in Table 1 apply to the cable connector on the scanner and are for reference only.

Table 1-2 Cable connector pin-outs descriptions

Pin	RS232	Keyboard (PS2)	USB
1	Power (+5V)	Power (+5V)	Power (+5V)
2	+3.3V (for interface auto selection purpose)	Ground (for interface auto selection purpose)	+3.3V (for interface auto selection purpose)
3	Ground	Ground	Ground
4	+3.3V (for interface auto selection purpose)	Reserved	Ground (for interface auto selection purpose)
5	TxD	KeyClock	Reserved
6	RxD	KeyData	Reserved
7	Reserved	TermClock	Reserved
8	Reserved	TermData	Reserved
9	CTS	Reserved	D-
10	RTS	Reserved	D+

Note: Voltage level of all RS232 Pin-outs (RxD, TxD, CTS and RTS) is 0V for logic low and 3.3V for logic high.

Default setting for each barcode

Table 2 Default setting for each barcode

Code type	Read enable	Check digit verification	Check digit transmission	Min. code length	Proprietary code ID	AIM code ID
UPC-A	√	√	√	(12) ²	A	JEm
UPC-E	√	√	√	(8) ²	D	JEm
UPC-E1	√	√	√	(8) ²	D	JEm
EAN-13	√	√	√	(13) ²	A	JEm
EAN-8	√	√	√	(8) ²	C	JEm
ISBN (Bookland EAN) / ISSN ¹	√	√	√	(13) ²	B	JEm
Code 39	√	-	-	1	M	JAm
Interleaved 2 of 5	√	-	-	6	I	JIm
Industrial 2 of 5	-	-	-	4	H	JIm
Matrix 2 of 5	√	-	-	6	X	JIm
Codabar	√	-	-	4	N	JFm
Code 128	√	√	-	1	K	JCm
UCC/EAN 128	√	√	-	1	K	JCm
ISBT 128	√	√	-	1	K	JCm
Code 93	√	√	-	1	L	JGm
Code 11	-	√	-	4	V	-
MSI/Plessey	-	-	-	4	O	JMm
UK/Plessey	√	√	-	1	U	JMm
China Post	√	-	-	(11) ²	T	JIm
China Finance	√	-	-	(10) ²	Y	-
GS1 DataBar	√	-	-	(16) ²	R	Jem
GS1 DataBar Truncated ³	√	-	-	(16) ²	R	Jem
GS1 DataBar Limited	√	-	-	(16) ²	R	Jem
GS1 DataBar Expanded	√	-	-	1	R	Jem

Note: ¹The settings for ISBN/ISSN and EAN-13 must be the same except the code ID.

² Fixed-length barcodes.

³The settings for GS1 DataBar Truncated and GS1 DataBar must be the same.

Decode zone

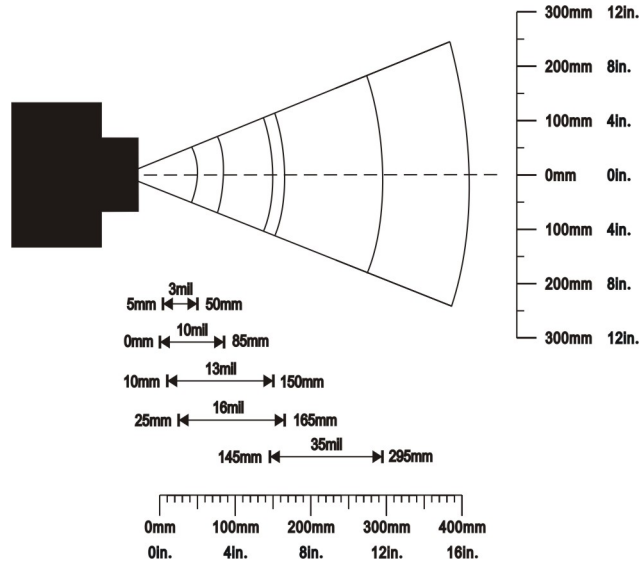

High-density series

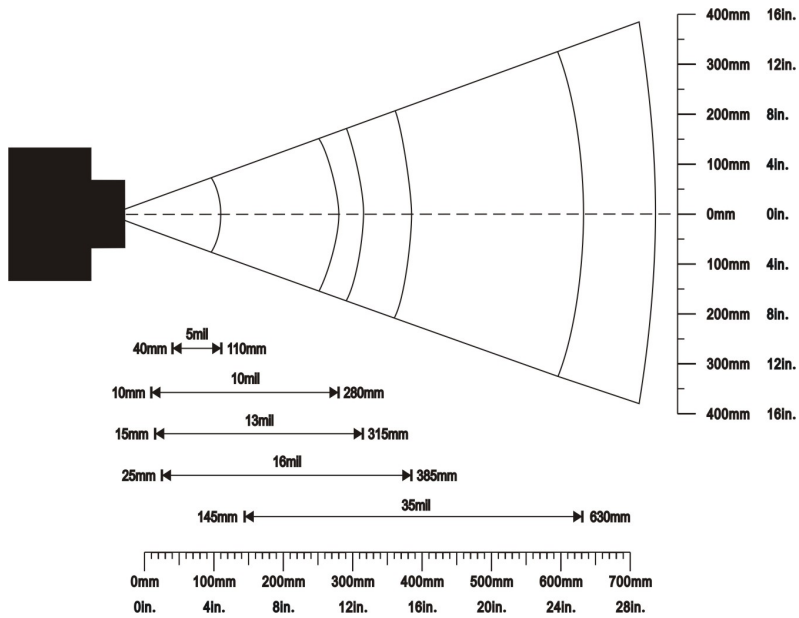

Long-range series

Dimensions

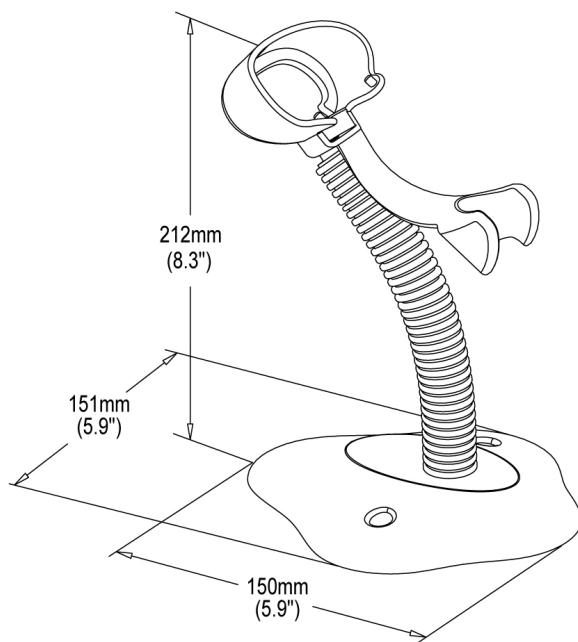
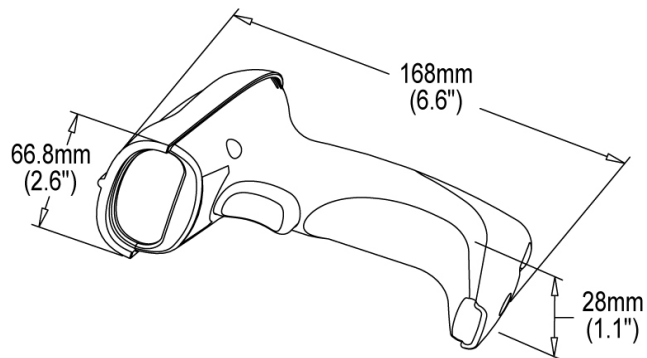
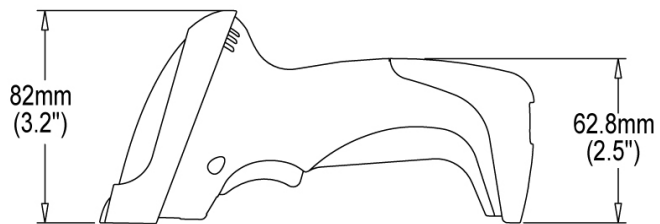

Parts of the scanner

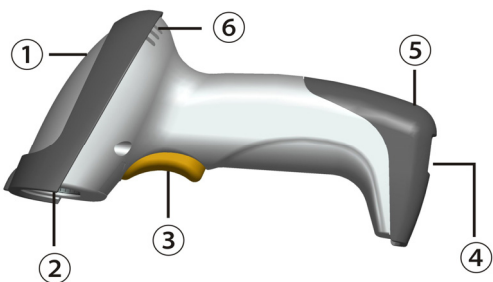

Figure 1

- ① LED
- ② Exit window
- ③ Trigger
- ④ Cable interface port
- ⑤ Release-hole of the cable
- ⑥ Beeper

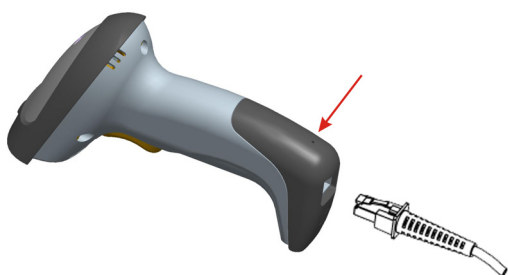

Figure 2

Remove the interface cable:

1. Find the release-hole.
2. Insert a thin wire into the hole and pull out the cable gently.

Introduction to installation

Note: If any of the below operation is incorrect, turn off the power immediately and check the scanner for any improper connections. Go through all steps again.

Installation - keyboard wedge

1. Switch off the host and unplug the keyboard connector.
2. Attach the modular connector of the Y-cable to the cable interface port on the scanner.
3. Connect the round male DIN host connector of the Y-cable to the keyboard port on the host device.
4. Connect the round female DIN keyboard connector of the Y-cable to the keyboard.
5. Ensure that all connections are secure.
6. Switch on the host system.

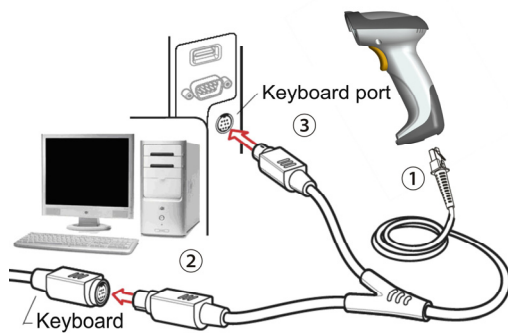

Figure 3

Installation - RS-232

1. Connect the RS-232 interface cable to the bottom of the scanner.
2. Connect the other end of the interface cable to the serial port on the host. Tighten the two screws to secure the connector to the port.
3. If the host does not have power supply (on PIN 9), connect the external power supply (DC adapter) to the RS-232 cable.

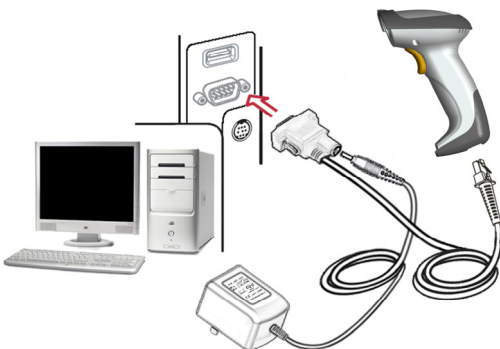

Figure 4

Installation - USB

The scanner attaches directly to a USB host, and is powered by it. No additional power supply is required.

1. Refer to Figure 5, connect the USB interface cable to the bottom of the scanner.
2. Plug the series A connector in the USB host, or an available port of the terminal.
3. Windows will automatically detect the USB device.

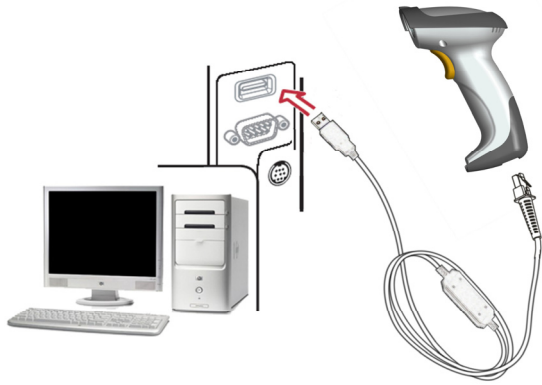
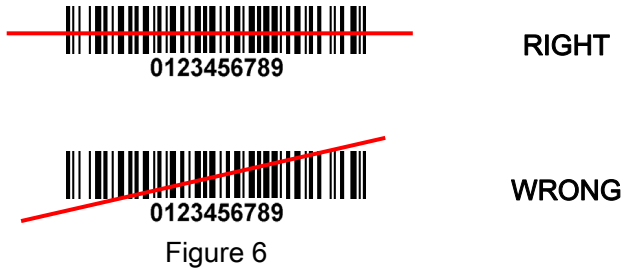

Figure 5

Scanning modes

The scanner has two scanning modes: hand-held and auto-detection. When the scanner is scanning, ensure the scan line crosses every bar and space of the symbol.



The auto-detection scanning mode has two operating modes: in-stand and always ON. The following is an introduction to in-stand auto-detection mode.

1. When the scanner is seated in the stand, the scanner operates in auto-detection mode (see Figure 7). When scanner is removed from the stand, it operates in its normal hand-held mode.
2. To scan a bar code, present the bar code and ensure the scan line crosses every bar and space of the symbol.
3. Upon successful decode, the scanner beeps and the LED lights.
4. When the laser light is off, the present bar code must be removed to active next scanning.



Figure 7

Programming instruction

Refer to the next page, the steps of programming are:

1. Scan the **SETUP** bar code on the parameter setting part.
2. Enter the option mode by scanning the **Option bar code**.
3. To the right of the option barcode, the necessary alphanumeric inputs are listed. Scan these alphanumeric entries.
4. Scan the **END** bar code, listed on the lower right hand corner of each parameter setting part.
5. **Notes that only one parameter can be setup at each time.**
6. During the process of programming, LED is lighting to indicate the programming correctness. LED will go off if any incorrect programming operation performed.
7. After each successful programming, LED will go off and the scanner will beep twice.
8. Throughout the programming bar code menus, **the factory default settings are indicated with asterisks (*)**.

Example: to set **Flow control** to be XON/XOFF.

Steps: Scan the following barcodes in order.

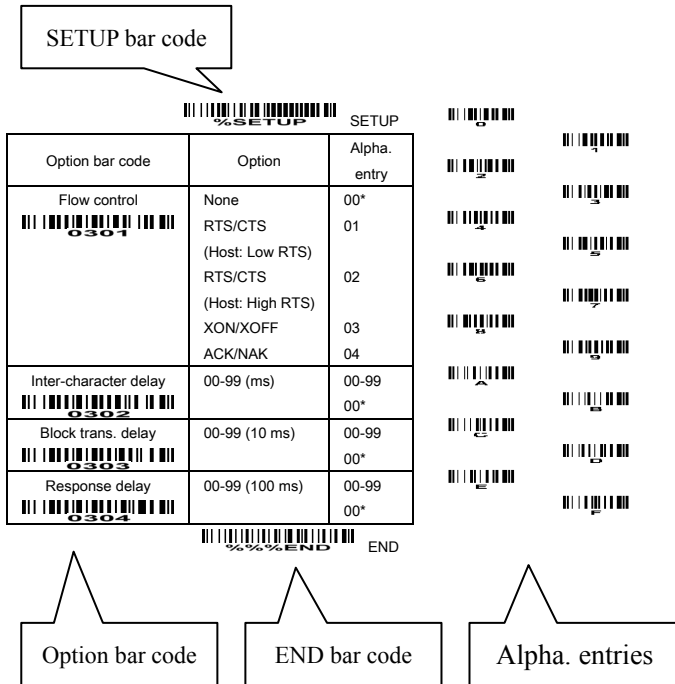
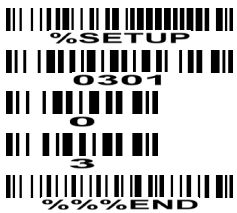

Figure 7

Operate the scanner by receiving command via UART

Note:

- 1- The information in this chapter is provided for the scanner with RS232 cable or USB cable.
- 2- If the scanner is with USB cable, the setting of **USB device type** must be set as "USB virtual COM". Please refer to chapter of "USB interface".
- 3- Please read the chapter of "Scanning & some global settings" about the setting of **Scanning mode** in details.

UART parameter should be set as below:

- (1) Baud rate: 9600 bps;
- (2) Data bits: 8 bits;
- (3) Stop bit: 1 bit;
- (4) Parity check bit: None;
- (5) Flow control: None.

Guide of control command: all commands are sent by UART

- 1) Start command: "0x54" (T)

When the scanner received the above command, it will start barcode scanning following the setting of **Scanning mode**. If the scanner is in the mode of "Auto-detection", the scanner will have a single scan, then returns to "Auto-detection" mode.

- 2) Stop command: "0x50" (P)

If the **Scanning mode** is set as "Alternate continue" or "Continue", and the scanner received the above command, it will stop barcode scanning and act as in an idle mode.

- 3) Restart command: "0x35" (R)

Once the scanner received the above command, it will restart.

Returning message from the scanner

- 1) A successful decode

Once the scanner successfully decoded a barcode, the scanner will stop scanning and returns the barcode data to the Host.

- 2) Not a successful decode

Once the scanner failed to decode a barcode before stopping scanning, the scanner will return a message to the Host. The message is set as "0x25, 0x25, 0x4E, 0x6F, 0x52, 0x65, 0x61, 0x64" (%%NoRead).

Interface selection

This scanner supports interfaces such as keyboard wedge, RS-232 serial wedge, and USB interface. In most of the cases, simply selecting an appropriate cable provided by the manufacturer will work for a specific interface.

Interface selection:

Auto detection-By setting this function, the scanner will automatically detect the keyboard wedge, RS-232 or USB interface for user.

%SETUP SETUP

Option bar code	Option	Alpha. entry
Interface selection  0101	Auto detection (Keyboard wedge /RS-232/USB) Keyboard wedge RS-232 USB	00* 01 02 03

%%%END END

Keyboard wedge interface

Keyboard type: As a keyboard interface, the scanner supports most of the popular PCs and IBM terminals.

Keyboard layout: The scanner supports different national keyboard layouts.

Clock period: According to the PS2 protocol, the clock is provided by the device, e.g. keyboard or scanner, with the period between 60us to 100us.

Delay-after-compound-key: In some rare occasions, machine with low speed PS2 communication port would require a free time gap following the press/release of the compound key (Shift, Ctrl or Alt).

Numeric key:

Alphabetic key- the scanner will output code result as alphabetic key.

Numeric key- the scanner will output code result as pressing numeric keypad ('0', '1', '2', '3', '4', '5', '6', '7', '8', '9', '.', '+', '-', '/', '*' only).

Alt+ keypad- the scanner will output code result as pressing Alt+ numeric key (on keypad). Note that the Num Lock control key must be ON. This setting can be specially adapted for use with different national keyboard layout.

Power-on simulation: All of the PCs check the keyboard status during power-on self test. It simulates keyboard timing and passes keyboard present status to the PC during power-on.

Inter-character delay: This delay is inserted after each data character transmitted.

Inter-byte delay: This delay is inserted after each byte transmitted. Normally a character is comprised of three or above bytes.









Block trans. delay: It is a delay timer between barcode data output. This feature is used to transfer continually with shorter barcode data.

Caps Lock reversion: By setting enable, the status of Caps Lock key (i.e. being pressed ON or OFF) on the keyboard is simulated in a reversion status.

Caps Lock override: If this function is enabled, on AT or AT notebook hosts, the keyboard ignores the state of the Caps Lock key. Therefore, an 'A' in the bar code is sent as an 'A' no matter what the state of the keyboard's Caps Lock key.

A guide of setting while the scanned data is incorrectly displayed on the host

- ✚ If some characters are missed or some additional characters are incorrectly displayed on the host, set the Inter-byte delay (0208) to be "01" or greater value.
- ✚ If some capital character (e.g. "A") or compound-key-characters (e.g. "shift+", "Ctrl +", "Alt+") are displayed incorrectly, set the Delay-after-compound-key to be "01" or greater value.
- ✚ If some digits are incorrectly displayed as some symbol characters (e.g. "1" and "2" are displayed incorrectly as "!" and "@"), set the Clock period (0203) to be greater value (e.g. 04, 05).

Option bar code	Option	Alpha. entry
Keyboard type  0201	IBM AT, PS/2 Apple Mac compatibles	00* 01
Keyboard layout  0202	USA Turkish F Turkish Q French Italian Spanish Slovak Denmark Japanese German Belgian Russian	00* 01 02 03 04 05 06 07 08 09 10 11
Clock period  0203	60us 70us 80us 90us 100us 200us	00 01 02* 03 04 05
Delay-after-compound-key  0204	0ms 10ms 20ms 40ms 80ms	00* 01 02 03 04
Numeric key  0205	Alphabetic key Numeric keypad Alt+ keypad	00* 01 02
Power-on simulation  0206	Disable Enable	00* 01
Inter-character delay  0207	0ms 5ms 10ms 20ms 40ms 80ms	00* 01 02 03 04 05
Inter-byte delay  0208	1ms 2ms 4ms 8ms	00* 01 02 03
Caps Lock reversion  0209	Disable Enable	00* 01
Caps Lock override	Disable	00*

 %SETUP SETUP

Option bar code	Option	Alpha. entry
 0210	Enable	01

 %%%END END

RS-232 interface

Flow control:

None-The communication only uses TxD and RxD signals without any hardware or software handshaking protocol.









RTS/CTS-If the scanner wants to send the barcode data to host computer, it will issue the RTS signal first, wait for the CTS signal from the host computer, and then perform the normal data communication. If there is no replied CTS signal from the host computer after the timeout duration, the scanner will issue an error indication. By setting (Host idle: Low RTS) or (Host idle: High RTS), the scanner can be set to match the Serial Host RTS line.

XON/XOFF-An XOFF character turns the scanner transmission off until the scanner receives an XON character.

ACK/NAK-After transmitting data, the scanner expects either an ACK (acknowledge) or NAK (not acknowledge) response from the host. When a NAK is received, the scanner transmits the same data again and waits for either an ACK or NAK. After three unsuccessful attempts to send data when NAKs are received, the scanner issues an error indication and discards the data.

Inter-character delay: Refer to Inter-character delay of Keyboard wedge.

Response delay: This delay is used for serial communication of the scanner when it waits for a handshaking acknowledgment from the host.

Option bar code	Option	Alpha. entry
Flow control  0301	None RTS/CTS (Host idle: Low RTS) RTS/CTS (Host idle: High RTS) XON/XOFF ACK/NAK	00* 01 02 03 04
Inter-character delay  0302	0ms 5ms 10ms 20ms 40ms 80ms	00* 01 02 03 04 05
Reserved  0303		
Response delay  0304	00-99 (100ms)	00-99 00*
Baud rate  0305	300 600 1200 2400 4800 9600 19200 38400 57600 115200	00 01 02 03 04 05* 06 07 08 09
Parity  0306	None Odd Even	00* 01 02
Data bit  0307	8 bits 7 bits	00* 01
Stop bit  0308	One bit Two bits	00* 01

USB interface

USB device type:

HID keyboard– By setting, the scanner is used as a USB HID keyboard emulation device. The keyboard layout setting follows the setting of keyboard layout in the chapter of Keyboard wedge.

USB virtual COM– By setting, the scanner emulate a regular RS232-based COM port. If a Microsoft Windows PC is connected to the scanner, a driver is required to install on the connected PC. The driver will use the next available COM Port number. The driver and the installation guide can be found in the associated CD and on the manufacturer's website. A Windows-based software COM_Text is recommended to display the barcode data in text format. COM_Text emulates some kind of serial-key typing.

Note: when changing USB Device Types, the scanner automatically restarts.

Simple COM Port Emulation- Please contact the manufacturer for the instruction.

Keyboard layout: The scanner supports different national keyboard layouts.

Inter-character delay: This delay is inserted after each data character transmitted. By selecting, the user can change the output speed of the scanner to match the speed of the host USB communication port.





Numeric key:

Alphabetic key- the scanner will output code result as alphabetic key.

Numeric key- the scanner will output code result as pressing numeric keypad ('0', '1', '2', '3', '4', '5', '6', '7', '8', '9', '.', '+', '-', '/', '*' only).

Alt+ keypad- the scanner will output code result as pressing Alt+ numeric key (on keypad). Note that the Num Lock control key must be ON. This setting can be specially adapted for use with different national keyboard layout.

 %SETUP SETUP

Option bar code	Option	Alpha. entry
USB device type  0901	HID keyboard	00*
	HID keyboard for Apple Mac	01
	USB virtual COM	02
	Simple COM Port Emulation	03
Keyboard layout  0902	USA	00*
	Turkish F	01
	Turkish Q	02
	French	03
	Italian	04
	Spanish	05
	Slovak	06
	Denmark	07
	Japanese	08
	German	09
	Belgian	10
Russian	11	
Inter-character delay  0903	0ms	00
	5ms	01*
	10ms	02
	20ms	03
	40ms	04
	60ms	05
Numeric key  0904	Alphabetic key	00*
	Numeric keypad	01
	Alt+ keypad	02

 %%%END END

Hand-held scan & some global settings

Scanning mode:

Good-read off-The trigger button must be pressed once to activate scanning. The light source of scanner stops scanning when there is a successful reading or no code is decoded after the **Stand-by duration** elapsed.

Momentary-The trigger button acts as a switch. Press button to activate scanning and release button to stop scanning. The light source of scanner stops scanning when there is a successful reading or no code is decoded after the **Stand-by duration** elapsed.

Alternate continue-The trigger button acts as a toggle switch. Press button to activate or stop scanning.

Continue-The scanner always keeps scanning, and it does not matter when the trigger button is pressed or duration is elapsed.

Timeout off-The trigger button must be pressed once to activate scanning. The light source of scanner stops scanning when no code is successful decoded after the **Stand-by duration** elapsed.

Same barcode delay time: If a barcode has been scanned and output once successfully, the laser beam must be off or moved away from the barcode beyond delay time to active scanning the same barcode. When this feature is set to be "0xFF", then the delay time is indefinite.

Double confirm: If it is enabled, the scanner will require a several times of same-decoded-data to confirm a valid reading.

Global Max./Min. code length: These two lengths are defined as the valid range of decoded barcode data length. Make sure that the minimum length setting is no greater than the maximum length setting, or otherwise the labels of the symbol will not be readable. In particular, the same value can be set for both minimum and maximum reading length to force the fixed length barcode decoded.

Notes:

1. Please set the max./min. length for individual barcode in later sections, if special demand is requested.
2. The number of check digits is included in max./min. code length.
3. These two settings have no effect on the symbols with fixed-length, e.g. UPC-A, UPC-E, EAN-13, EAN-8 and China Post.

Global G1-G6 string selection: The scanner offer one or two string group for ALL symbols. By setting one or two digits to indicate which string group you want to apply. You may refer to the chapters of "String setting" and "String position & Number of truncated leading/ending character".

Example: Group 1 → set 01 or 10. Group 2 and 4 → set 24 or 42.

All valid settings include 00, 01, 02, 03, 04, 05, 06, 10, 11, 12, 13, 14, 15, 16, 20, 21, 22, 23, 24, 25, 26, 30, 31, 32, 33, 34, 35, 36, 40, 41, 42, 43, 44, 45, 46, 50, 51, 52, 53, 54, 55, 56, 60, 61, 62, 63, 64, 65 and 66.

Element amendment: If it is enabled, the scanner can read the barcode comprised with bars and spaces in different scale.

Character output restraint:

Printable character only- If this option is selected, the scanner will output the printable characters only,











i.e. in ASCII from 20H to 7EH.

Alphanumeric character only- If this option is selected, the scanner will output the alphanumeric characters only, i.e. "A"-“Z”, "a"-“z”, "0"-“9”.

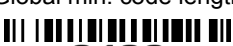
Decoder optimization: If it is enabled, the scanner will optimize the decoder with error correction. This function is not effective for all types of barcodes.

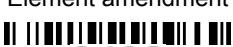
Data output delay in continue-scan mode: If it is enabled, in the continue-scan mode, the scanner can store the data while continue-scanning. The scanner will output the data after the predefined delay elapsed. The maximum storage of data is 1000 characters. If this parameter is set to be "00", the scanner will not store data. And if the parameter is set to be "FF", the scanner will output data after stopping scanning.

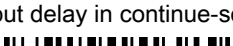
Enter sleeping-mode delay: The scanner will enter sleeping mode if the scanner has been in the idle mode after the predefined delay elapsed. The scanner will be awakened by pressing the trigger once.

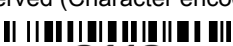
Option bar code	Option	Alpha. entry
Scanning mode  0401	Good-read off Momentary Alternate continue Continue Timeout off	00 01* 02 03 04
Standby duration  0402	01-99 (second)	01-99 04*
Same barcode delay time  0403	00-FF ₁₆ (50ms)	00-FF ₁₆ 08*
Double confirm  0404	00-09 (00: no)	00-09 00*
Global max. code length  0405	04-99	04-99 99*
Global min. code length  0406	01-99	01-99 04*
Global G1-G6 string selection  0407	00-66	00-66 00*
Element amendment  0408	Disable Enable	00 01*
Character output restraint  0409	None Printable character only Alphanumeric character only	00* 01 02
Decoder optimization  0410	Disable Enable	00 01*
Data output delay in continue-scan mode  0411	00-99 (100ms) FF (Never)	00-FF ₁₆ 00*
Enter sleeping-mode delay  0412	15 min 30 min 60 min Never	00 01* 02 03
Reserved (Character encoding)  0413		

Indication

Power on alert: After power-on the scanner will generate an alert signal to indicate a successful self-test.

LED indication: After each successful reading, the LED above the scanner will light up to indicate a good barcode reading.

Beeper indication: After each successful reading, the scanner will beep to indicate a good barcode reading, and its beep tone duration is adjustable.

Beep tone duration: This parameter can be adjusted for a good reading upon favorite usage.

Volume of beeper: This parameter can be adjusted for different level of the volume of the beeper.

|||||
%SETUP SETUP

Option bar code	Option	Alpha. entry
Power on alert 0501	Disable Enable	00 01*
LED indication 0502	Disable Enable	00 01*
Beeper indication 0503	Disable Enable	00 01*
Beep tone duration 0504	01-09 (10ms)	01-09 05*
Volume of beeper 0505	Low Middle High	00 01 02*

|||||
%%%END END

Auto-detection scan

Auto-detect sensor: By setting Enable, the scanner will start operating if any nearby object has been detected. The laser light of scanner stops scanning when there is a successful reading or no code is decoded after the **Stand-by duration** elapsed. Once the laser light stops scanning, the present object must be removed to enable **Auto-detect sensor**.



Operating mode:

In-stand-auto-detection- The scanner must be placed in the stand to enable **Auto-detect sensor**.

Auto-detection-always-ON- **Auto-detect sensor** is always enabled regardless of the placement of the scanner.

In-stand-continue- The scanner must be placed in the stand to enable the scanning mode to be set as continue.



Option bar code	Option	Alpha. entry
Auto-detect sensor  0601	Disable Enable	00 01*
Operation mode  0602	In-stand-auto-detection Auto-detection-always-ON In-stand-continue	00* 01 02
Stand-by duration  0603	00-99 (second)	00-99 04*



One step setting



%0602D02%

UPC-A

Read: Format

System character	Data digits (10 digits)	Check digit
------------------	-------------------------	-------------

Check digit verification: The check digit is optional.

Check digit trans.: By setting Enable, check digit will be transmitted.

Code ID setting: Code ID is a one-or-two-character string used to represent the symbol upon a succeeding reading. If you want application to transmit Code ID, you must set **Code ID transmission** to be enabled. Refer to the chapter of String transmission.

Insertion group selection: Refer to **Global insertion group selection** of the chapter of Hand-held scan & some global settings.

Supplement digits: The Supplement digits barcode is the supplemental 2 or 5 characters.

Format

System character	Data digits (10 digits)	Check digit	Supplement digits 2 or 5
------------------	-------------------------	-------------	--------------------------

Truncation/Expansion:









Truncate leading zeros- The leading “0” digits of UPC-A data characters can be truncated when the feature is enabled.

Expand to EAN-13- It extends to 13-digits with a “0” leading digit when the feature is enabled.

Truncate system character- The system character of UPC-A data can be truncated when the feature is enabled.

Add country code- The country code (“0” for USA) can be added when the feature is enabled.

%SETUP SETUP

Option bar code	Option	Alpha. entry
Read  1101	Disable Enable	00 01*
Check digit verification  1102	Disable Enable	00 01*
Check digit trans.  1103	Disable Enable	00 01*
Code ID setting  1104	00-FF ₁₆ (ASCII)	00-FF ₁₆ <A>*
Insert group selection  1105	00-66	00-66 00*
Supplement digits  1106	None 2 digits 5 digits 2 or 5 digits	00* 01 02 03
Truncation/Expansion  1107	None Truncate leading zeros Expand to EAN-13 Truncate system character Add country code	00* 01 02 03 04
Reserved  1108		

%%%END END

UPC-E

Read: Format

System character "0"	Data digits (6 digits)	Check digits
----------------------	------------------------	--------------

Check digit verification: The check digit is optional and made as the sum of the numerical value of the data digits.

Check digit trans.: By setting Enable, check digit will be transmitted.

Code ID setting: Refer to

Code ID setting

 of UPC-A.

Insertion group selection: Refer to

Insertion group selection

 of UPC-A.

Supplement digits:

Format

System character "0"	Data digits (6 digits)	Check digit	Supplement digits 2 or 5
----------------------	------------------------	-------------	--------------------------

Truncation/Expansion:

Truncate leading zeros- Refer to

Truncation/Expansion

 of UPC-A.

Expand to EAN-13- It extends to 13-digits with "0" digits when the feature is set to be enabled.









Example: Barcode "0123654",

Output: "0012360000057".

Expand to UPC-A- It extends to 12-digits when the feature is set to be enabled.

Truncate system character- The system character "0" of UPC-E data can be truncated when the feature is enabled.

 %SETUP SETUP

Option bar code	Option	Alpha. entry
Read  1201	Disable Enable	00 01*
Check digit verification  1202	Disable Enable	00 01*
Check digit trans.  1203	Disable Enable	00 01*
Code ID setting  1204	00-FF ₁₆ (ASCII)	00-FF ₁₆ <D>*
Insert group selection  1205	00-66	00-66 00*
Supplement digits  1206	None 2 digits 5 digits 2 or 5 digits	00* 01 02 03
Truncation/Expansion  1207	None Truncate leading zeros Expand to EAN-13 Expand to UPC-A Truncate system character	00* 01 02 03 04
Reserved  1208		

 %%%END END

UPC-E1

Read: Format

System character "1"	Data digits (6 digits)	Check digits
----------------------	------------------------	--------------

Check digit verification: The check digit is optional and made as the sum of the numerical value of the data digits.

Check digit trans.: By setting Enable, check digit will be transmitted.

Code ID setting: Refer to

Code ID setting

 of UPC-A.

Insertion group selection: Refer to

Insertion group selection

 of UPC-A.

Supplement digits:

Format

System character "1"	Data digits (6 digits)	Check digit	Supplement digits 2 or 5
----------------------	------------------------	-------------	--------------------------









Truncation/Expansion:

Expand to EAN-13- It extends to 13-digits with "0" digits when the feature is set to be enabled.

Expand to UPC-A- It extends to 12-digits when the feature is set to be enabled.

Truncate system character- The system character "1" of UPC-E1 data can be truncated when the feature is enabled.

 %SETUP SETUP

Option bar code	Option	Alpha. entry
Read  3401	Disable Enable	00 01*
Check digit verification  3402	Disable Enable	00 01*
Check digit trans.  3403	Disable Enable	00 01*
Code ID setting  3404	00-FF ₁₆ (ASCII)	00-FF ₁₆ <D>*
Insert group selection  3405	00-66	00-66 00*
Supplement digits  3406	None 2 digits 5 digits 2 or 5 digits	00* 01 02 03
Truncation/Expansion  3407	None Reserved Expand to EAN-13 Expand to UPC-A Truncate system character	00* 01 02 03 04
Reserved  3408		

 %%%END END

EAN-13 (ISBN/ISSN)

Read:

Format

Data digits (12 digits)	Check digit
-------------------------	-------------

Check digit verification: The check digit is optional and made as the sum of the numerical value of the data digits.

Check digit transmission: By setting Enable, check digit will be transmitted.

EAN-13 code ID setting: Refer to

Code ID setting

 of UPC-A.

Insertion group selection: Refer to

Insertion group selection

 of UPC-A.

Supplement digits:

Format

Data digits (12 digits)	Check digit	Supplement digits 2 or 5
-------------------------	-------------	--------------------------

ISBN/ISSN: The ISBN (International Standard Book Number, or Bookland EAN) and ISSN (International Standard Serial Number) are two kinds of barcode for books and magazines. The ISBN is 10 digits with leading “978” and the ISSN is 8 digits with leading “977” of the EAN-13 symbol.

Example:

Barcode “9780194315104”, Output: “019431510X”.









Barcode “9771005180004”, Output: “10051805”.

ISBN/ISSN code ID setting: Refer to

Code ID setting

 of UPC-A.

 %SETUP SETUP

Option bar code	Option	Alpha. entry
Read  1301	Disable Enable	00 01*
Check digit verification  1302	Disable Enable	00 01*
Check digit transmission  1303	Disable Enable	00 01*
EAN-13 code ID setting  1304	00-FF ₁₆ (ASCII)	00-FF ₁₆ <A>*
Insert group selection  1305	00-66	00-66 00*
Supplement digits  1306	None 2 digits 5 digits 2 or 5 digits	00* 01 02 03
ISBN/ISSN conversion  1307	Disable Enable	00* 01
Reserved  1308		
ISBN/ISSN code ID setting  1309	00-FF ₁₆ (ASCII)	00-FF ₁₆ *

 %%%END END

EAN-8

Read:

Format

Data digits (7 digits)	Check digit
------------------------	-------------

Check digit verification: The check digit is optional and made as the sum of the numerical value of the data digits.

Check digit trans.: By setting Enable, check digit will be transmitted.

Code ID setting: Refer to

Code ID setting

 of UPC-A.

Insertion group selection: Refer to

Insertion group selection

 of UPC-A.

Supplement digits:

Format









Data digits (7 digits)	Check digit	Supplement Digits 2 or 5
------------------------	-------------	--------------------------

Truncation/Expansion: Refer to

Truncation/Expansion

 of UPC-A.

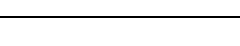
 %SETUP SETUP

Option bar code	Option	Alpha. entry
Read  1401	Disable Enable	00 01*
Check digit verification  1402	Disable Enable	00 01*
Check digit trans.  1403	Disable Enable	00 01*
Code ID setting  1404	00-FF ₁₆ (ASCII)	00-FF ₁₆ <C>*
Insert group selection  1405	00-66	00-66 00*
Supplement digits  1406	None 2 digits 5 digits 2 or 5 digits	00* 01 02 03
Truncation/Expansion  1407	None Truncate leading zero Expand to EAN-13	00* 01 02
Reserved  1408		

 %%%END END

Code 39 (Code 32, Trioptic Code 39)

Read:

Format

★	Data digits (variable)	Check digit (optional)	★
---	------------------------	------------------------	---

Check digit verification: The check digit is optional and made as the sum module 43 of the numerical value of the data digits.

Check digit transmission: By setting Enable, check digit will be transmitted.

Max./Min. code length: Each symbol has own max./min. code length. If both setting of max./min. code length are "00"s, the setting of global max./min. code length is effective. The length is defined as to the actual barcode data length to be sent. Label with length exceeds these limits will be rejected. Make sure that the minimum length setting is no greater than the maximum length setting, or otherwise all the labels of the symbol will not be readable. In particular, you can see the same value for both minimum and maximum reading length to force the fixed length barcode decoded.

Code ID setting: Refer to

Code ID setting

 of UPC-A.

Insertion group selection: Refer to

Insertion group selection

 of UPC-A.

Start/End transmission: The start and end characters of Code 39 are "★"s. You can transmit all data digits including two "★"s.

"★" as data character: By setting Enable, "★" can be recognized as data character.

Convert Code 39 to Code 32: Code 32 is a variant of Code 39 used by the Italian pharmaceutical industry. Note that Code 39 must be enabled in order for this parameter to function.

Format of Code 32

"A" (optional)	Data digits (8 digits)	Check digit
----------------	------------------------	-------------







Code 32 Prefix "A" transmission: By setting Enable, the prefix character "A" can be added to all Code 32 barcodes.

Trioptic Code 39 read: Trioptic Code 39 is a variant of Code 39 used in the marking of magnetic tapes and computer cartridges. Trioptic Code 39 symbols always contain six characters.

Format

\$	Data digits (6 digits)	\$
----	------------------------	----

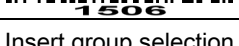
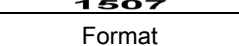
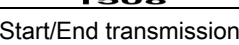
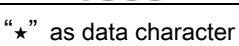
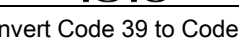
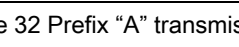
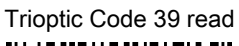
Trioptic Code 39 Start/End transmission: The start and end characters of Trioptic Code 39 are "\$"s. You can transmit all data digits including two "\$"s.

Option bar code	Option	Alpha. entry
Read  1501	Disable Enable	00 01*
Check digit verification  1502	Disable Enable	00* 01
Check digit transmission  1503	Disable Enable	00* 01
Max. code length  1504	00-99	00-99 00*
Min. code length  1505	00-99	00-99 01*
Code ID setting  1506	00-FF ₁₆ (ASCII)	00-FF ₁₆ <M>*
Insert group selection  1507	00-66	00-66 00*
Format  1508	Standard Full ASCII	00* 01
Start/End transmission  1509	Disable Enable	00* 01
“*” as data character  1510	Disable Enable	00* 01
Convert Code 39 to Code 32  1511	Disable Enable	00* 01
Code 32 Prefix “A” transmission  1512	Disable Enable	00* 01
Trioptic Code 39 read  1513	Disable Enable	00* 01
Trioptic Code 39 Start/End transmission  1514	Disable Enable	00* 01

Note 1: If Trioptic Code 39 is set Enable, Code 39 is forced Enable.
 Note 2: If Code 39 is set Disable, Trioptic Code 39 is forced Disable.

Interleaved 2 of 5

Read:

Format

Data digits (Variable)	Check digit (optional)
------------------------	------------------------

Check digit verification: The check digit is made as the sum module 10 of the numerical values of all data digits. There are two optional check digit algorithms: the specified Uniform Symbol Specification (USS) and the Optical Product Code Council (OPCC).









Check digit transmission: By setting Enable, check digit will be transmitted.

Max./Min. code length: Refer to Max./Min. code length of Code 39.

Code ID setting: Refer to Code ID setting of UPC-A.

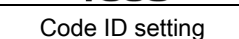
Insertion group selection: Refer to Insertion group selection of UPC-A.

 %SETUP SETUP

Option bar code	Option	Alpha. entry
Read  1601	Disable Enable	00 01*
Check digit verification  1602	Disable USS OPCC	00* 01 02
Check digit transmission  1603	Disable Enable	00* 01
Max. code length  1604	00-99	00-99 00*
Min. code length  1605	00-99	00-99 06*
Code ID setting  1606	00-FF ₁₆ (ASCII)	00-FF ₁₆ < >*
Insert group selection  1607	00-66	00-66 00*
Reserved  1608		

 %%%END END

Industrial 2 of 5

Read:

Format







Data digits (variable)

Max./Min. code length: Refer to Max./Min. code length of Code 39.

Code ID setting: Refer to Code ID setting of UPC-A.

Insertion group selection: Refer to Insertion group selection of UPC-A.



Option bar code	Option	Alpha. entry
Read  1701	Disable Enable	00* 01
Max. code length  1702	00-99	00-99 00*
Min. code length  1703	00-99	00-99 00*
Code ID setting  1704	00-FF ₁₆ (ASCII)	00-FF ₁₆ <H>*
Insert group selection  1705	00-66	00-66 00*
Reserved  1706		



Matrix 2 of 5

Read:

Format

Data digits (variable)	Check digit (optional)
------------------------	------------------------

Check digit verification: The check digit is made as the sum module 10 of the numerical values of all data digits.





Check digit transmission: By setting Enable, check digit will be transmitted.

Max./Min. code length: Refer to Max./Min. code length of Code 39.

Code ID setting: Refer to Code ID setting of UPC-A.

Insertion group selection: Refer to Insertion group selection of UPC-A.

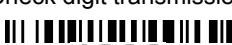
 %SETUP SETUP

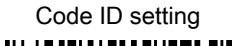
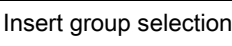
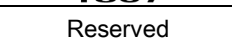
Option bar code	Option	Alpha. entry
Read  1801	Disable Enable	00 01*
Check digit verification  1802	Disable Enable	00* 01
Check digit transmission  1803	Disable Enable	00* 01
Max. code length  1804	00-99	00-99 00*
Min. code length  1805	00-99	00-99 06*
Code ID setting  1806	00-FF ₁₆ (ASCII)	00-FF ₁₆ <X>*
Insert group selection  1807	00-44	00-44 00*
Reserved  1808		

 %%%END END

Codabar

Read:

Format

Start	Data digits (variable)	Check digit (optional)	End
-------	------------------------	------------------------	-----

Check digit verification: The check digit is made as the sum module 16 of the numerical values of all data digits.

Check digit transmission: By setting Enable, check digit will be transmitted.

Max./Min. code length: Refer to **Max./Min. code length** of Code 39.

Code ID setting: Refer to **Code ID setting** of UPC-A.

Insertion group selection: Refer to **Insertion group selection** of UPC-A.

Start/End type: Codabar has four pairs of Start/End pattern; you may select one pair to match your application.

Start/End transmission: Refer to **Start/End transmission** of Code 39.

Start/End character equality: By setting Enable, the start and end character of a Codabar barcode must be the same.



Option bar code	Option	Alpha. entry
Read 1901	Disable Enable	00 01*
Check digit verification 1902	Disable Enable	00* 01
Check digit transmission 1903	Disable Enable	00* 01
Max. code length 1904	00-99	00-99 00*
Min. code length 1905	00-99	00-99 00*
Code ID setting 1906	00-FF ₁₆ (ASCII)	00-FF ₁₆ <N>*
Insert group selection 1907	00-66	00-66 00*
Start/End type 1908	ABCD/ABCD abcd/abcd ABCD/TN*E abcd/tn*e	00* 01 02 03
Start/End transmission 1909	Disable Enable	00* 01
Start/End character equality 1910	Disable Enable	00* 01



Code 128

Read:

Format

Data digits (variable)	Check digit (optional)
------------------------	------------------------

Check digit verification: The check digit is made as the sum module 103 of all data digits.

Check digit transmission: By setting Enable, check digit will be transmitted.









Max./Min. code length: Refer to Max./Min. code length of Code 39.

Code ID setting: Refer to Code ID setting of UPC-A.

Insertion group selection: Refer to Insertion group selection of UPC-A.

Truncate leading zeros: The leading "0" digits of Code 128 barcode characters can be truncated when the feature is enabled.



Option bar code	Option	Alpha. entry
Read  2001	Disable Enable	00 01*
Check digit verification  2002	Disable Enable	00 01*
Check digit transmission  2003	Disable Reserved	00* 01
Max. code length  2004	00-99	00-99 00*
Min. code length  2005	00-99	00-99 01*
Code ID setting  2006	00-FF ₁₆ (ASCII)	00-FF ₁₆ <K>*
Insert group selection  2007	00-66	00-66 00*
Truncate leading zeros  2008	Disable All leading "0"s Only the first "0"	00* 01 02



UCC/EAN 128

Read:

Format

Data digits (variable)	Check digit (optional)
------------------------	------------------------

Check digit verification: The check digit is made as the sum module 103 of all data digits.

Check digit transmission: By setting Enable, check digit will be transmitted.

Max. /Min. code length: Refer to Max./Min. code length of Code 39.

Code ID setting: Refer to Code ID setting of UPC-A.

Insertion group selection: Refer to Insertion group selection of UPC-A.

Truncate leading zeros: Refer to Truncate leading zeros of Code 128.



Option bar code	Option	Alpha. entry
Read 2501	Disable Enable	00 01*
Check digit verification 2502	Disable Enable	00 01*
Check digit transmission 2503	Disable Reserved	00* 01
Max. code length 2504	00-99	00-99 00*
Min. code length 2505	00-99	00-99 01*
Code ID setting 2506	00-FF ₁₆ (ASCII)	00-FF ₁₆ <K>*
Insert group selection 2507	00-66	00-66 00*
Truncate leading zeros 2508	Disable All leading "0"s Only the first "0"	00* 01 02



ISBT 128

Read:

Format

"=" or "&"	Data digits (variable)	Check digit (optional)
------------	------------------------	------------------------

Check digit verification: The check digit is made as the sum module 103 of all data digits.









Check digit transmission: By setting Enable, check digit will be transmitted.

Max./Min. code length: Refer to Max./Min. code length of Code 39.

Code ID setting: Refer to Code ID setting of UPC-A.

Insertion group selection: Refer to Insertion group selection of UPC-A.

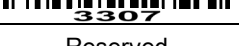
 %SETUP SETUP

Option bar code	Option	Alpha. entry
Read  3301	Disable Enable	00 01*
Check digit verification  3302	Disable Enable	00 01*
Check digit transmission  3303	Disable Reserved	00* 01
Max. code length  3304	00-99	00-99 00*
Min. code length  3305	00-99	00-99 01*
Code ID setting  3306	00-FF ₁₆ (ASCII)	00-FF ₁₆ <K>*
Insert group selection  3307	00-66	00-66 00*
Reserved  3308	-	-

 %%%END END

Code 93

Read:

Format

Data digits (variable)	2 check digits (optional)
------------------------	---------------------------

Check digit verification: The check digit is made as the sum module 47 of the numerical values of all data digits.









Check digit transmission: By setting Enable, check digit will be transmitted.

Max./Min. code length: Refer to Max./Min. code length of Code 39.

Code ID setting: Refer to Code ID setting of UPC-A.

Insertion group selection: Refer to Insertion group selection of UPC-A.

 %SETUP SETUP

Option bar code	Option	Alpha. entry
Read  2101	Disable Enable	00 01*
Check digit verification  2102	Disable Enable	00 01*
Check digit transmission  2103	Disable Enable	00* 01
Max. code length  2104	00-99	00-99 00*
Min. code length  2105	00-99	00-99 01*
Code ID setting  2106	00-FF ₁₆ (ASCII)	00-FF ₁₆ <L>*
Insert group selection  2107	00-66	00-66 00*
Reserved  2108		

 %%%END END

Code 11

Read:

Format

Data digits (variable)	Check digit 1 (optional)	Check digit 2 (optional)
------------------------	---------------------------	--------------------------

Check digit verification: The check digit is presented as the sum module 11 of all data digits.









Check digit transmission: By setting Enable, check digit 1 and check digit 2 will be transmitted upon your selected check digit verification method.

Max./Min. code length: Refer to Max./Min. code length of Code 39.

Code ID setting: Refer to Code ID setting of UPC-A.

Insertion group selection: Refer to Insertion group selection of UPC-A.

 %SETUP SETUP

Option bar code	Option	Alpha. entry
Read  2201	Disable Enable	00* 01
Check digit verification  2202	Disable One digit Reserved Reserved	00 01* 02 03
Check digit transmission  2203	Disable Enable	00* 01
Max. code length  2204	00-99	00-99 00*
Min. code length  2205	00-99	00-99 00*
Code ID setting  2206	00-FF ₁₆ (ASCII)	00-FF ₁₆ <V>*
Insert group selection  2207	00-66	00-66 00*
Reserved  2208		

 %%%END END

MSI/Plessey

Read:

Format

Data digits (variable)	Check digit 1 (optional)	Check digit 2 (optional)
------------------------	--------------------------	--------------------------

Check digit verification: The MSI/Plessey has one or two optional check digits. There are three methods of verifying check digits, i.e. Mod10, Mod10/10 and Mod 11/10. The check digit 1 and check digit 2 will be calculated as the sum module 10 or 11 of the data digits.









Check digit transmission: By setting Enable, check digit 1 and check digit 2 will be transmitted upon your selected check digit verification method.

Max./Min. code length: Refer to Max./Min. code length of Code 39.

Code ID setting: Refer to Code ID setting of UPC-A.

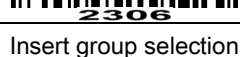
Insertion group selection: Refer to Insertion group selection of UPC-A.

 %SETUP SETUP

Option bar code	Option	Alpha. entry
Read  2301	Disable Enable	00* 01
Check digit verification  2302	Disable 1 digit (mod 10) Reserved Reserved	00* 01 02 03
Check digit transmission  2303	Disable Enable	00* 01
Max. code length  2304	00-99	00-99 00*
Min. code length  2305	00-99	00-99 00*
Code ID setting  2306	00-FF ₁₆ (ASCII)	00-FF ₁₆ <O>*
Insert group selection  2307	00-66	00-66 00*
Reserved  2308		

 %%%END END

UK/Plessey

Read:

Format

Data digits (variable)	2 check digits (optional)
------------------------	---------------------------

Check digit verification: The UK/Plessey has one or two optional check digits. The check digit 1 and check digit 2 will be calculated as the sum module 10 or 11 of the data digits.







Check digit transmission: By setting Enable, check digit will be transmitted.

Max./Min. code length: Refer to Max./Min. code length of Code 39.

Code ID setting: Refer to Code ID setting of UPC-A.

Insertion group selection: Refer to Insertion group selection of UPC-A.

 %SETUP SETUP

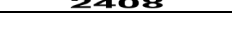
Option bar code	Option	Alpha. entry
Read  2401	Disable Enable	00* 01
Check digit verification  2402	Disable Enable	00 01*
Check digit transmission  2403	Disable Enable	00* 01
Max. code length  2404	00-99	00-99 00*
Min. code length  2405	00-99	00-99 01*
Code ID setting  2406	00-FF ₁₆ (ASCII)	00-FF ₁₆ <U>*
Insert group selection  2407	00-66	00-66 00*
Reserved  2408		

 %%%END END

China Post

Read:

Format









11 Data digits

Max. /Min. code length: Refer to Max./Min. code length of Code 39. The code length of China Post is 11.

Code ID setting: Refer to Code ID setting of UPC-A.

Insertion group selection: Refer to Insertion group selection of UPC-A.

 %SETUP SETUP

Option bar code	Option	Alpha. entry
Read  2601	Disable Enable	00 01*
Reserved  2602		
Reserved  2603		
Max. code length  2604	00-99	00-99 11*
Min. code length  2605	00-99	00-99 11*
Code ID setting  2606	00-FF ₁₆ (ASCII)	00-FF ₁₆ <T>*
Insert group selection  2607	00-66	00-66 00*
Reserved  2608		

 %%%END END

GS1 DataBar (GS1 DataBar Truncated)

GS1 DataBar Truncated is structured and encoded the same as the standard GS1 DataBar format, except its height is reduced to a 13 modules minimum; while GS1 DataBar should have a height greater than or equal to 33 modules.

Read:

Format

16 Data digits

Code ID setting: Refer to Code ID setting of UPC-A.





Insertion group selection: Refer to Insertion group selection of UPC-A.

Conversion:

UCC/EAN 128- Refer to Code ID transmission of String transmission,]Cm will be identified as AIM ID.

UPC-A or EAN-13- Barcode beginning with a single zero as the first digit has the leading "010" stripped and the barcode reported as EAN-13. Barcode beginning with two or more zeros but not six zeros has the leading "0100" stripped and the barcode reported as UPC-A.

 %SETUP SETUP

Option bar code	Option	Alpha. entry
Read  2701	Disable Enable	00 01*
Code ID setting  2702	00-FF ₁₆ (ASCII)	00-FF ₁₆ <R >*
Insert group selection  2703	00-66	00-66 00*
Conversion  2704	None UCC/EAN 128 UPC-A or EAN-13	00* 01 02
Reserved  2705		

 %%%END END

GS1 DataBar Limited

Read:

Format





16 Data digits

Code ID setting: Refer to **Code ID setting** of UPC-A.

Insertion group selection: Refer to **Insertion group selection** of UPC-A.

Conversion: Refer to **Conversion** of GS1 DataBar (GS1 DataBar Truncated).

 %SETUP SETUP

Option bar code	Option	Alpha. entry
Read  2801	Disable Enable	00 01*
Code ID setting  2802	00-FF ₁₆ (ASCII)	00-FF ₁₆ <R >*
Insert group selection  2803	00-66	00-66 00*
Conversion  2804	None UCC/EAN 128 UPC-A or EAN-13	00* 01 02
Reserved  2805		

 %%%END END

GS1 DataBar Expanded

Read:

Format

Data characters (variable)







Code ID setting: Refer to Code ID setting of UPC-A.

Insertion group selection: Refer to Insertion group selection of UPC-A.

Conversion:

UCC/EAN 128- Refer to Code ID transmission of String transmission,]Cm will be identified as AIM ID.

 %SETUP SETUP

Option bar code	Option	Alpha. entry
Read  2901	Disable Enable	00 01*
Max. code length  2902	00-99	00-99 00*
Min. code length  2903	00-99	00-99 01*
Code ID setting  2904	00-FF ₁₆ (ASCII)	00-FF ₁₆ <R >*
Insert group selection  2905	00-66	00-66 00*
Conversion  2906	None UCC/EAN 128	00* 01
Reserved  2907		

 %%%END END

China Finance

Note: This type of barcode is not Omni-directionally decodable. The encodable character set includes numeric 0 to 9. Among the symbol of 0 to 9, 0 and 2, 4 and 9, 5 and 8, 6 and 7, have the symmetrical pattern; the pattern of 1 and 3 is symmetrical.

Read:

Format

10 Data digits

Max./Min. code length: Refer to **Max./Min. code length** of Code 39.









Check digit verification: The check digit is made as the sum module 10 of the numerical values of all data digits.

Leading character 5/6/7/8/9 converted to A/B/C/D/E: By setting, leading character 5/6/7/8/9 can be converted to A/B/C/D/E.

Leading character assignment: By setting, only the barcode with the assigned leading character can be output.

Code ID setting: Refer to **Code ID setting** of UPC-A.

Insertion group selection: Refer to **Insertion group selection** of UPC-A.

Option bar code	Option	Alpha. entry
Read  3201	Disable Enable	00 01*
Max. code length  3202	00-99	00-99 10*
Min. code length  3203	00-99	00-99 10*
Check digit verification  3204	Disable Reserved	00* 01
Leading character 5/6/7/8/9 converted to A/B/C/D/E  3205	Disable Enable Only 5 converted to A Only 6 converted to B Only 7 converted to C Only 8 converted to D Only 9 converted to E	00 01* 02 03 04 05 06
Leading character assignment  3206	Disable Assigned to 0 Assigned to 5(A) Assigned to 6(B) Assigned to 7(C) Assigned to 8(D) Assigned to 9(E) Assigned to 1 Assigned to 2 Assigned to 3 Assigned to 4	00 01* 02 03 04 05 06 07 08 09 10
Code ID setting  3207	00-FF ₁₆ (ASCII)	00-FF ₁₆ <Y>*
Insert group selection  3208	00-66	00-66 00*



Laser Light Direction Setting: By scanning the barcode above, the decoding direction of the scanner's laser light is from left to right. By scanning the up-side-down barcode above, the decoding direction of the scanner's laser light is from right to left.

G1-G6 & FN1 substitution string setting

Format of barcode data transmission

Prefix	Code name	Preamble	Code ID	Code length	Code data	Code ID	Postamble	Suffix
--------	-----------	----------	---------	-------------	-----------	---------	-----------	--------

Suffix string setting: The <enter> key is represented in different ASCII when it is applied by different OS. For a Windows/DOS OS, <enter> is represented as <CR><LF> (0x0D 0x0A); for an Apple MAC OS, <enter> is represented as <CR> (0x0D); for a Linux/Unix OS, <enter> is represented as <LF> (0x0A).

Prefix/Suffix string setting: & Preamble/Postamble string setting:

They are appended to the data automatically when a barcode is decoded.

Example: Add a symbol of “\$” as a prefix for all symbols.

Steps:

- 1) Scan **SETUP** and **Prefix string setting** barcode.
- 2) Use the ASCII table to find the value of \$→24.
- 3) Scan **2** and **4** from the barcode on the foldout back page.
- 4) Scan **END** barcode.

Scanning steps: Scan the following barcodes in order.

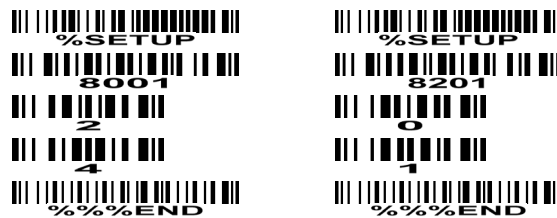

Insert G1/G2/G3/G4 string setting: The scanner offers 4 positions and 4 character strings to insert among the symbol.

Example: Set G1 string to be “AB”.

Original code data	“1 2 3 4 5 6”
Output code data	“1 2 A B 3 4 5 6”

Steps:

- 1) Scan **SETUP** and **Insert G1 string setting** barcode “8005”.
- 2) Use the ASCII table to find the value of A→41, B→42.
- 3) Scan **4**, **1** and **4**, **2** from the barcode on the foldout back page.
- 4) Scan **END** barcode.
- 5) Refer to the chapter of G1-G4 string position & Code ID position.
- 6) Refer to the chapter of Hand-held scan & some global settings.



Testing barcode:



FN1 substitution string setting: The FN1 character (0x1D) in an UCC/EAN128 barcode, or a Code 128 barcode, or a GS1 DataBar barcode can be substituted with a defined string.

Truncate leading G5 string setting: By setting, a defined leading character or string can be truncated. Also a single character can be un-defined.

Repeat of a G5 character setting: While G5 is set as a single defined/un-defined character, G5 can also be set to be repeated. This setting is ignored when the truncate number is more than the barcode data characters. The option of “FF” for this setting is not active while the option of **Truncate leading G5 string setting** is “00”.

Example: Truncate all leading zeros for all symbols.

Original code data	“0 0 0 1 2 3 4 5 6”
Output code data	“1 2 3 4 5 6”

Steps: scan the following data in order.

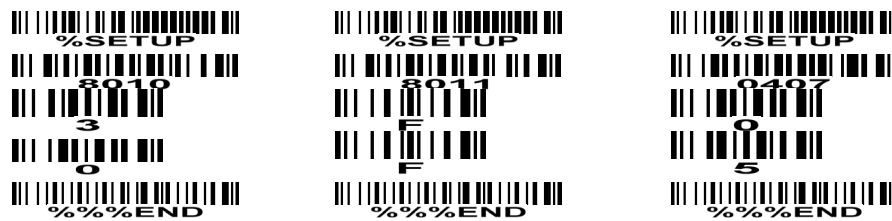

Testing barcode:



Truncate ending G6 string setting: By setting, a defined ending character or string can be truncated. Also a single character can be un-defined.

Repeat of a G6 character setting: While G5 is set as a single defined/un-defined character, G6 can also be set to be repeated. This setting is ignored when the truncate number is more than the barcode data characters. The option of “FF” for this setting is not active while the option of **Truncate ending G6 string setting** is “00”.

Single character C1/C2 replacement: By setting, a defined character in the data string can be replaced by another defined character. The C1 and C2 replacement are applied simultaneously.

Example: Replace all the “A” character in a data string to be “B” character.





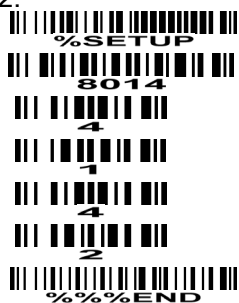









Original code data	“1 2 3 A 5 A”
Output code data	“1 2 3 B 5 B”

Steps: scan the following barcodes in order. The ASCII value for “A” is 41, and the ASCII value for “B” is 42.

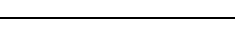

Testing barcode:

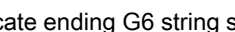
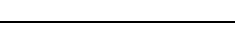

Option bar code	Option	Alpha. entry
Prefix string setting  8001	0-22 characters None	00-FF ₁₆ 00*
Suffix string setting  8002	0-22 characters <ENTER>	00-FF ₁₆ 0D0A*
Preamble string setting  8003	0-22 characters None	00-FF ₁₆ 00*
Postamble string setting  8004	0-22 characters None	00-FF ₁₆ 00*
Insert G1 string setting  8005	0-22 characters None	00-FF ₁₆ 00*
Insert G2 string setting  8006	0-22 characters None	00-FF ₁₆ 00*
Insert G3 string setting  8007	0-22 characters None	00-FF ₁₆ 00*
Insert G4 string setting  8008	0-22 characters None	00-FF ₁₆ 00*
FN1 substitution string setting  8009	0-4 characters <SP>	00-FF ₁₆ 20*
Truncate leading G5 string setting  8010	A un-defined character 1-22 defined characters <0>	00 01-7F ₁₆ 30*
Repeat of a G5 character setting  8011	Once Defined times Un-defined times (All)	01* 01-22 FF
Truncate ending G6 string setting  8012	A un-defined character 1-22 defined characters <0>	00 01-7F ₁₆ 30*
Repeat of a G6 character setting  8013	Once Defined times Un-defined times (All)	01* 01-22 FF
Single character C1 replacement  8014	<0000>	0000* 0000-FFFF ₁₆
Single character C2 replacement  8015	<0000>	0000* 0000-FFFF ₁₆

G1-G4 string position & Code ID position







Format of barcode data transmission

Prefix	Code name	Preamble	Code ID	Code length	Code data	Code ID	Postamble	Suffix
--------	-----------	----------	---------	-------------	-----------	---------	-----------	--------

Insert G1/G2/G3/G4 string position: The scanner offers 4 positions to insert strings among the symbol. In case of the insertion position is greater than the length of the symbol, the insertion of string is not effective.

Code ID position: It is allowed to select different positions of code ID placement.



Option bar code	Option	Alpha. entry
Insert G1 string position  8101	00-99	00-99 00*
Insert G2 string position  8102	00-99	00-99 00*
Insert G3 string position  8103	00-99	00-99 00*
Insert G4 string position  8104	00-99	00-99 00*
Code ID position  8105	Before code data After code data	00* 01
Reserved  8106		
Reserved  8107		



String transmission

Note: The information in this chapter is closely related to the chapter of String setting.

Format of barcode data transmission

Prefix	Code name	Preamble	Code ID	Code length	Code data	Code ID	Postamble	Suffix
--------	-----------	----------	---------	-------------	-----------	---------	-----------	--------

Prefix transmission: By setting Enable, prefix will be appended before the data transmitted.

Suffix transmission: By setting Enable, suffix will be appended after the data is transmitted.

Code name transmission: By setting Enable, code name will be transmitted before code data.

Preamble transmission: By setting Enable, preamble will be appended before the data transmitted.

Postamble transmission: By setting Enable, postamble will be appended after the data is transmitted.

Code ID transmission: Code ID can be transmitted in the format of either Proprietary ID or AIM ID. Refer to the chapter of Default setting for each barcode.

Code length transmission: The length of code data string can be transmitted before the code data when Enable is selected. The length is represented by a number with two digits.









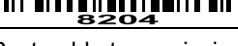

Case conversion: The characters within code data or the whole output string can be set in either upper case or lower case.

FN1 substitution transmission: The scanner supports a FN1 substitution feature for keyboard wedge, USB and RS-232 interface. The replacement string of FN1 can be chosen by user (see chapter of G1-G6 & FN1 substitution string setting).

All-non-printable-character string transmission with string setting: By setting enable, all string settings, e.g. Preamble transmission or Insert G1 string setting, are active for an all-non-printable-character string. Here a non-printable character means a character with ASCII value between 0x00 to 0x1F.

Transmit the first N data characters only: The scanner supports to only transmit the first N data characters of a barcode. The number of N can be set as a digit between 1 and 99.

Transmit the last N data characters only: The scanner supports to only transmit the last N data characters of a barcode. The number of N can be set as a digit between 1 and 99.

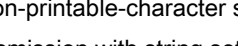
Option bar code	Option	Alpha. entry
Prefix transmission  8201	Disable Enable	00* 01
Suffix transmission  8202	Disable Enable	00 01*
Code name transmission  8203	Disable Enable	00* 01
Preamble transmission  8204	Disable Enable	00* 01
Postamble transmission  8205	Disable Enable	00* 01
Code ID transmission  8206	Disable Proprietary ID AIM ID	00* 01 02
Code length transmission  8207	Disable Enable	00* 01
Case conversion  8208	Disable Upper (data only) Lower (data only) Upper (whole string) Lower (whole string)	00* 01 02 03 04
FN1 substitution transmission  8209	Disable Keyboard wedge/USB RS-232 Keyboard wedge/USB/RS-232	00* 01 02 03
All-non-printable-character string transmission with string setting  8210	Disable Enable	00* 01
Transmit the first N data characters only  8211	All 01-99	99* 01-99
Transmit the last N data characters only  8212	All 01-99	99* 01-99

Test Chart

UPC-A

6 59871 23231 9

UPC-E

0 232310 7

EAN-8

0123 4510

EAN-13

1 234567 891019

Code 39

0189-.\$AZ

Code 32

A908765439

Code 128

01AZ[+~*/]za98

Interleaved 2 of 5

0123456789

Industrial 2 of 5
(Default setting: Read disable)

0123456789

Matrix 2 of 5

9876543210

Code 93

01AZ+~/*az89

UCC/EAN 128

01AZ[]+~az54

Code 11
(Default setting: Read disable)

123456789-0

Test Chart (Continued)

MSI/Plessey

(Default setting: Read disable)



0123456789

UK/Plessey



01ABEF89

ISBN/ISSN



9 780194 315104

China Post



54789632145

GS1 DataBar (GS1 DataBar Truncated)



1234567890123

GS1 DataBar Limited



987654321012

GS1 DataBar Expanded



Ab_09+yZ

Troubleshooting

Problem	Possible causes	Possible solutions
Nothing happens when you follow the operating instructions, or the scanner displays erratic behavior.	No power to the scanner.	Check the system power. Ensure the power supply is connected.
	Incorrect cables.	Use the original cables.
	Connections are loose.	Check for loose cable connections.
Laser comes on, but the scanner does not decode.	Bar code symbol is unreadable.	Check the symbol to make sure it is not defaced. Try scanning test symbols of the same bar code type.
	Scanner is not programmed for the correct bar code type.	Be sure the scanner is programmed to read the type of bar code you are scanning.
	Distance between scanner and bar code is incorrect.	Move the scanner closer to or further from the bar code.
Scanned data is incorrectly displayed on the host.	Scanner is not programmed to work with the host. Check scanner host type parameters or editing options.	<p>Be sure proper host is selected.</p> <p>For RS-232, ensure the scanner's communication parameters match the host's settings.</p> <p>For a USB-HID keyboard or a keyboard wedge configuration, ensure the system is programmed for the correct keyboard type and language, and the CAPS LOCK key is in the correct state.</p>
Other circumstances.		Contact your distributor or the manufactory support centre.

Maintenance

Cleaning the exit window is the only maintenance required. A dirty window may affect scanning accuracy.

1. Do not allow any abrasive material to touch the window.
2. Remove any dirt particles with a damp cloth.
3. Wipe the window using a tissue moistened with water.
4. Do not spray water or other cleaning liquids directly into the window.
5. Use a piece of soft and dry cloth when cleaning the scanner.

Assembling the stand

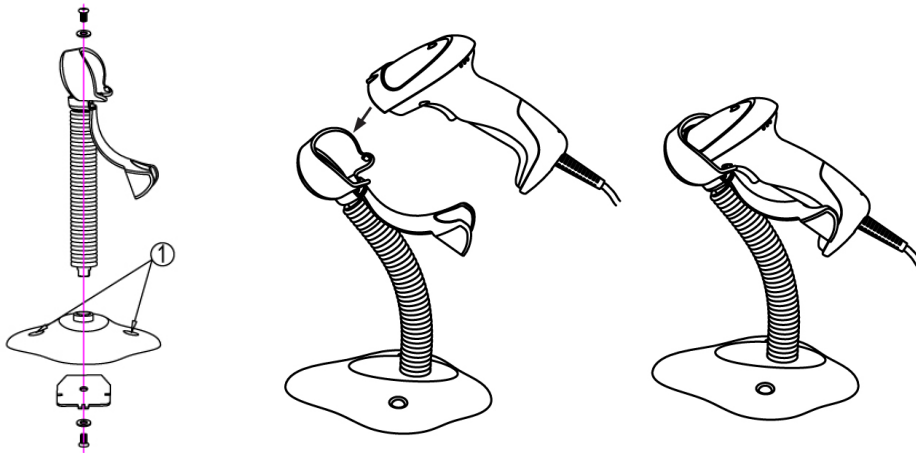

1. See the figure above, tighten the screws.
2. Bend the neck to the desired position for scanning.
3. Screw mounting: Screw one #10 wood screw into each screw-mount-hole until the base of the stand is secured.
4. Tape mounting: ①Peel the paper liner off one side of each piece of tape and place the sticky surface over each of the three rectangular tape holders. ②Peel the paper liner off the exposed sides of each piece of tape and press the stand on a flat surface until it is secure.

ASCII Table

		for keyboard wedge		for RS-232	
H L	0	1	0	1	
0	Null		NUL	DLE	
1	Up	F1	SOH	DC1	
2	Down	F2	STX	DC2	
3	Left	F3	ETX	DC3	
4	Right	F4	EOT	DC4	
5	PgUp	F5	ENQ	NAK	
6	PgDn	F6	ACK	SYN	
7		F7	BEL	ETB	
8	Bs	F8	BS	CAN	
9	Tab	F9	HT	EM	
A		F10	LF	SUB	
B	Home	Esc	VT	ESC	
C	End	F11	FF	FS	
D	Enter	F12	CR	GS	
E	Insert	Ctrl+	SO	RS	
F	Delete	Alt+	SI	US	

Notes: The 2nd and the 3rd columns above are used for keyboard wedge only.

H L	2	3	4	5	6	7
0	SP	0	@	P	`	p
1	!	1	A	Q	a	q
2	“	2	B	R	b	r
3	#	3	C	S	c	s
4	\$	4	D	T	d	t
5	%	5	E	U	e	u
6	&	6	F	V	f	v
7	‘	7	G	W	g	w
8	(8	H	X	h	x
9)	9	I	Y	i	y
A	*	:	J	Z	j	z
B	+	;	K	[k	{
C	,	<	L	\	l	
D	-	=	M]	m	}
E	.	>	N	^	n	~
F	/	?	O	_	o	DEL

Example: ASCII “A” = “41”.

Barcode representing non-printable character

Notes to make the following barcode:

1. According to different barcode printing software, the method of printing following barcode is different.
2. If using CODESOFT software, firstly read the information through “Help→Index→Code128→Special input syntax”. Also refer to ASCII table. For example, if we wish to make “F1” barcode, select “code128”, then select “CODE A” type, and input “{DOC1}” as data.



Up ↑



Down ↓



Left ←



Right →



Page Up



Page Down



Backspace



Tab



Home



End



Enter



Insert



Delete



F1



F2



F3



F4



F5



F6



F7



F8



F9



F10



Esc



F11



F12

Return default parameters & others



%%%DEF

WARNING: Default value initialization

If you wish to return the scanner to all the factory default settings, scan the barcode above.



%%%VER

Firmware version list

If you wish to display the firmware version, scan the barcode above.

Configuration alphanumeric entry barcode



0



1



2



3



4



5



6



7



8



9



A



B



C



D



E



F